

Installation / User Manual

Photovoltaic Grid-connected
Microinverter(Built-in WIFI-G4)

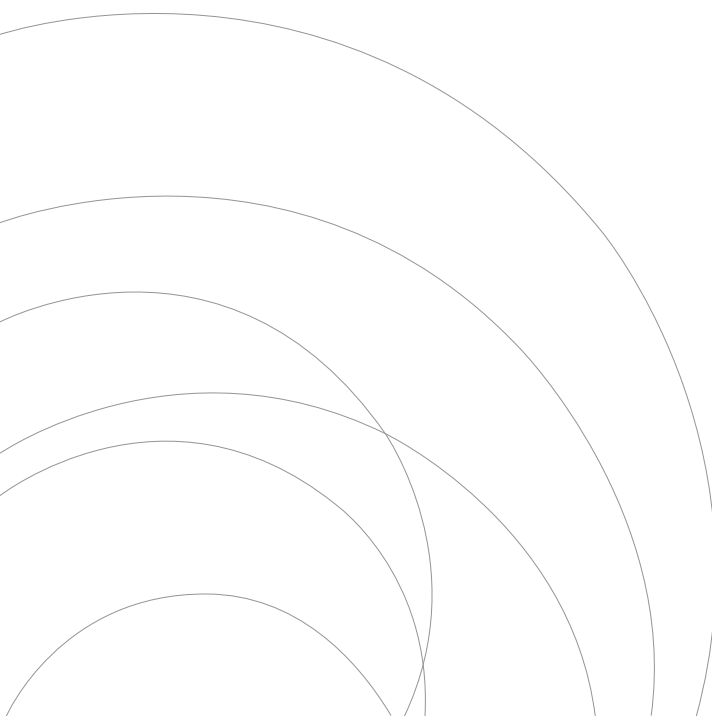

Table of Contents

Important Safety Instructions	01
Safety Instructions	
Radio Interference Statement	
The Meaning of Symbols	
Microinverter System Introduction	03
Microinverters Maximize PV Energy Production	
More Reliable than Centralized or String Inverters	
Simple to Install	
Microinverter Introduction	05
Microinverter System Installation	06
Required Parts and Tools from You	
Parts list	
Installation Procedures	
Microinverter System Operating Instructions	11
Troubleshooting	12
Status Indications and Error Reporting	
Troubleshooting a Non-operating Microinverter	
Replacement	15
Technical Data	15
M 130 / 160 / 180 / 200 / 220 / 225G4-I Microinverter Datasheet	
Wiring Diagram	18
Monitoring Platform	20
How to connect the Microinverter to the router via web	21
How to connect in APP	25
Maintenance	27
Troubleshooting	27

Important Safety Instructions

This manual contains important instructions to follow during installation and maintenance of the Photovoltaic Grid-connected Inverter(Microinverter).To reduce the risk of electrical shock and ensure the safe installation and operation of the Microinverter the following symbols appear throughout this document to indicate dangerous conditions and important safety instructions.

Specifications subject to change without notice - please ensure you are using the latest manual found at the manufacturer website.

WARNING: This indicates a situation where failure to follow instructions may cause a serious hardware failure or personnel danger if not applied appropriately. Use extreme caution when performing this task.

NOTE: This indicates information that is important for optimized Microinverter operation. Follow these instructions strictly.

CAUTION: IMPORTANT TO READ CAREFULLY AND KEEP FOR EVENTUAL REQUESTS.

Safety Instructions

- ✓ **DO NOT** disconnect the PV module from the Microinverter without disconnecting the AC power.
- ✓ Only qualified professionals should install and/or replace the Microinverters.
- ✓ Perform all electrical installations in accordance with local electrical codes.
- ✓ Before installing or using the Microinverter, please read all instructions and cautionary markings in the technical documents and on the Microinverter system and the solar-array.
- ✓ Be aware that the body of the Microinverter is the heat sink and can reach a temperature of 80°C. To reduce risk of burns,do not touch the body of the Microinverter.
- ✓ When the microinverter is working properly, please maintain a distance of at least 20 cm from it.
- ✓ **DO NOT** attempt to repair the Microinverter. If it fails, contact technical support to obtain an RMA number and start the replacement process. Damaging or opening the Microinverter will void the warranty.
- ✓ Caution!
The external protective earthing conductor is connected to the inverter protective earthing terminal through AC connector.
When connecting, connect the AC connector first to ensure the inverter earthing then do the DC connections.
When disconnecting, disconnect the AC by opening the branch circuit breaker first

but maintain the protective earthing conductor in the branch circuit breaker connect to the inverter ,then disconnect the DC inputs.

- ✓ In any circumstance, do not connect DC input when AC connector is unplugged.
- ✓ Please install isolation switching devices on the AC side of the inverter.

Radio Interference Statement

The equipment could radiate radio frequency energy and this might cause harmful interference to radio communications if not following the instructions when installing and using the equipment. But there is no guarantee that interference will not occur in a particular installation. If this equipment causes harmful interference to radio or television reception,the following measures might resolve the issues:

- A) Relocate the receiving antenna and keep it well away from the equipment.
- B) Consult the dealer or an experienced radio / TV technical for help.

Changes or modifications not expressly approved by the party responsible for compliance may void the user's authority to operate the equipment.

WiFi information





Frequency range:2.412~2.472GHz

WiFi maximum transmitting power:16dBm \pm 2dBm

Antenna: External Antenna

Antenna Gain:2.00dBi

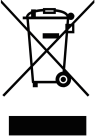
The Meaning of Symbols

Labels	Description
	Caution, risk of electric shock.
	Caution, risk of burn - Do not touch.
	Caution, hot surface.
	Symbol for the marking of electrical and electronics devices according to Directive 2002/96/EC. Indicates that the device, accessories and the packaging must not be disposed as unsorted municipal waste and must be collected separately at the end of the usage. Please follow Local Ordinances or Regulations for disposal or contact an authorized representative of the manufacturer for information concerning the decommissioning of equipment.
	CE mark is attached to the solar inverter to verify that the unit follows the provisions of the European RED Directives.
	Refer to the operating instructions.
Qualified personnel	Person adequately advised or supervised by an electrically skilled person to enable him or her to perceive risks and to avoid hazards which electricity can create. For the purpose of the safety information of this manual, a "qualified person" is someone who is familiar with requirements for safety, refrigeration system and EMC and is authorized to energize, ground, and tag equipment, systems, and circuits in accordance with established safety procedures. The inverter and endues system may only be commissioned and operated by qualified personnel.

Microinverter System Introduction

The Microinverter is used in utility-interactive grid-tied applications, comprised of two key elements:

- Microinverter
- Router

This series Microinverter has built-in WIFI module so it can communicate with router directly.

130/160/180/200/220/225G4

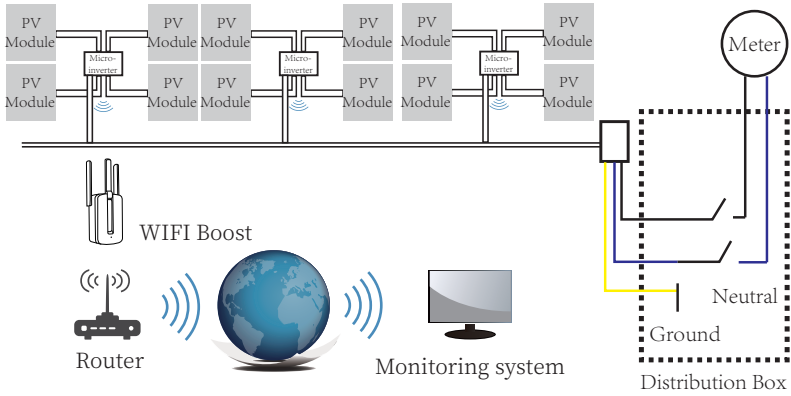

Inverter Model	SUN-M130G4-EU-Q0-I	SUN-M160G4-EU-Q0-I	SUN-M180G4-EU-Q0-I	SUN-M200G4-EU-Q0-I	SUN-M220G4-EU-Q0-I	SUN-M225G4-EU-Q0-I
PV Input Voltage	42.5V (20V-60V)					
PV Array MPPT Voltage Range	25V-55V					
No. of MPP Trackers	4					
No. of Strings per MPP Tracker	1					

NOTE: If the wireless signal in the area where the Microinverter is installed is weak, it is necessary to add a wifi signal booster at a suitable place between the router and the Microinverter.

This integrated system improves safety; maximizes solar energy harvest; increases system reliability, and simplifies solar system design, installation, maintenance, and management.

Microinverters Maximize PV Energy Production

Each PV module has individual Maximum Peak Power Tracking (MPPT) controls, which ensures that the maximum power is exported to the utility grid regardless of the performance of the other PV modules in the array. When PV modules in the array are affected by shade, dust, orientation, or any situation in which one module underperforms compared with the other units, the Microinverter ensures top performance from the array by maximizing the performance of each module within the array.

More Reliable than Centralized or String Inverters

The distributed Microinverter system ensures that no single point of system failure exists across the PV system. Microinverters are designed to operate at full power at ambient outdoor temperatures of up to 113°F (45°C). The inverter housing is designed for outdoor installation and complies with the IP67 environmental enclosure rating.

Simple to Install

You can install individual PV modules in any combination of Module quantity, orientation, different type and power rate. The Ground wire (PE) of the AC cable is connected to the chassis inside of the Microinverter, potentially eliminating the installation of grounding wire (check local regulation).

Data collection adopts internal wifi, wireless router is needed near the Microinverter. When complete the installation of Microinverter, configure wireless router with internal wifi (refer to the wifi user manual). The data will be uploaded automatically. Users can monitor and manage the Microinverter through corresponding website or APP.

Microinverter Introduction

The Microinverters connect with the single-phase grid, and can also use multiple Microinverters in the form of single-phase grid to achieve three-phase grid.

For more information, please see the Technical Data page (P16-P17) of this manual.

Model Number	AC grid	Max. # Per branch
SUN-M130G4-EU-Q0-I	50/60Hz, 220/230V	5 for 40A breaker
SUN-M160G4-EU-Q0-I	50/60Hz, 220/230V	4 for 40A breaker
SUN-M180G4-EU-Q0-I	50/60Hz, 220/230V	3 for 40A breaker
SUN-M200G4-EU-Q0-I		3 for 40A breaker
SUN-M220G4-EU-Q0-I		3 for 40A breaker

Microinverter System Installation

A PV system using Microinverters is simple to install. Each Microinverter easily mounts on the PV racking, directly beneath the PV module(s). Low voltage DC wires connect from the PV module directly to the Microinverter, eliminating the risk of high DC voltage. Installation MUST comply with local regulations and technical rules.

WARNING: Perform all electrical installations in accordance with local electrical codes.

WARNING: Be aware that only qualified professionals should install and/or replace Microinverters.

WARNING: Before installing or using an Microinverter, please read all instructions and warnings in the technical documents and on the Microinverter system itself as well as on the PV array.

WARNING: Be aware that installation of this equipment includes the risk of electric shock.

NOTE: Strongly recommend to install Surge protection Devices in the dedicated meter box.

NOTE: The product is suitable for residential, commercial and light industrial environments, not for industrial environments.





Required Parts and Tools from you

In addition to your PV array and its associated hardware, you will need the following items:

- An or several AC connection junction boxes
- Mounting hardware suitable for module racking
- Sockets and wrenches for mounting hardware
- Continuous grounding conductor and grounding washers
- A Phillips screwdriver
- A torque wrench

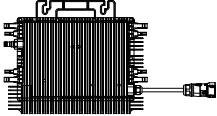
Parts list

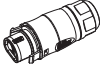
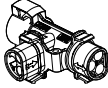
Please check the following table, to see whether all the parts are included in the package:

 <p>Microinverter x1</p>	 <p>User manual x1</p>	 <p>AC extension cable (optional) x N-1</p>
 <p>Bus AC connector (optional) x1</p>	 <p>T-connector (optional) x N-1</p>	 <p>Clip x1</p>

* Choose either Bus AC connector or Extension cable with European standard plug, can't use them in the same project.

* The externa relay has been well connected with Microinverter before delievery, and it can't be disconnected with Microinverter by customer or distributor by themselves. The unauthorized disconnection of external relay with Microinverter will cause the invalid of warranty.

Installation Procedures

Step 1 - Install the AC branch circuit junction box

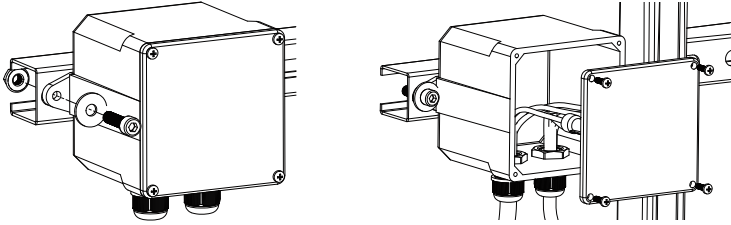

- Install an appropriate junction box at a suitable location on the PV racking system (typically at the end of a branch of modules).
- Connect the open wire end of the AC cable into the junction box using an appropriate gland or strain relief fitting.
- Connect the AC branch circuit junction box to the point of utility Grid Interconnection (Usually it is inside a distribution box).

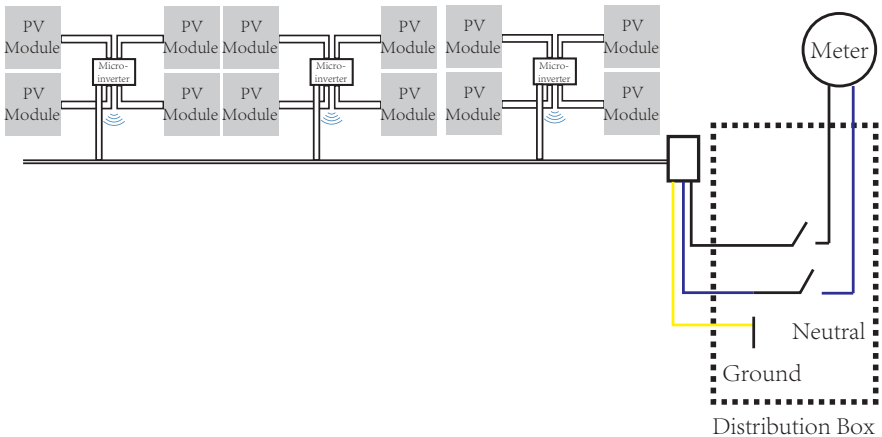

WARNING: Wiring colour code can be different according local regulation,check all the wires of the installation before connecting to the AC cable to be sure they match. Wrong cabling can damage irreparably the Microinverters,such an issue is not covered by the warranty.

Step 2 - Attach the Microinverters to the racking or the PV module frame

- a. Mark the location of the Microinverter on the rack, with respect to the PV module and junction box or any other obstructions.
- b. Mount one Microinverter at each of these locations using hardware recommended by your module racking vendor.

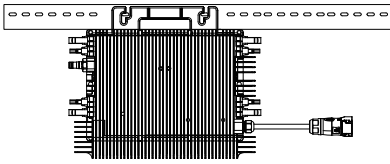

130/160/180/200/220 G4 (4MPPT) Mounting

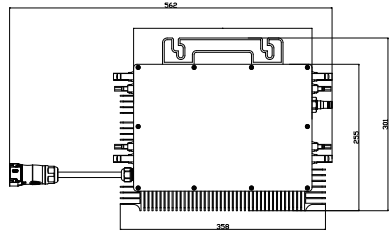

The AC wire on the Microinverter is a TC-ER wire with a wire cross-section area of 1mm^2 (16AWG).

WARNING: Prior to installing any of the Microinverters, verify that the utility voltage at the point of common connection matches the voltage rating on Microinverter label.

WARNING: Do not place the inverters (including DC and AC connectors) where exposed to the sun, rain or snow, even gap between modules. Allow a minimum of $3/4$ (1.5cm.) between the roof and the bottom of the Microinverter to allow proper air flow.

Step 3 - Connect the Microinverters in parallel

- a. Check the Microinverter technical data page 6 for the maximum allowable number of Microinverters on each AC branch circuit.
- b. As to parallel connection, please refer to page (P18-P19), use the T-connector, AC extension cable, Bus AC connector to connect the Microinverter in each branch.

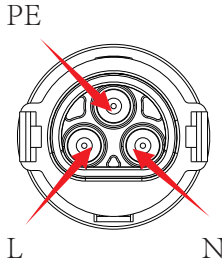

Male connector

Model	Wire Size	Cable(mm) ²	Torque value(max)	Max cable length
SUN-M130G4-EU-Q0-I	10AWG	4.0	1.0Nm	Outside cable (L+N+PE)20m
SUN-M160G4-EU-Q0-I	10AWG	4.0	1.0Nm	
SUN-M180G4-EU-Q0-I	10AWG	4.0	1.0Nm	
SUN-M200G4-EU-Q0-I	10AWG	4.0	1.0Nm	
SUN-M220G4-EU-Q0-I	10AWG	4.0	1.0Nm	

WARNING: DO NOT exceed maximum number of Microinverters in an AC branch circuit, as displayed on the page 6 of this manual.

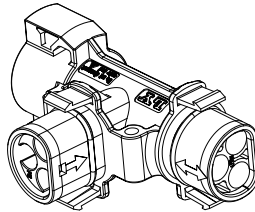

T-connector

NOTE: Port marked with two-way arrow on T-type plug can only connect with extended cable and Port marked with one-way arrow on T-type plug can only connect with Microinverter.

Step 4 - Connect the wire open of branch end to the junction box.

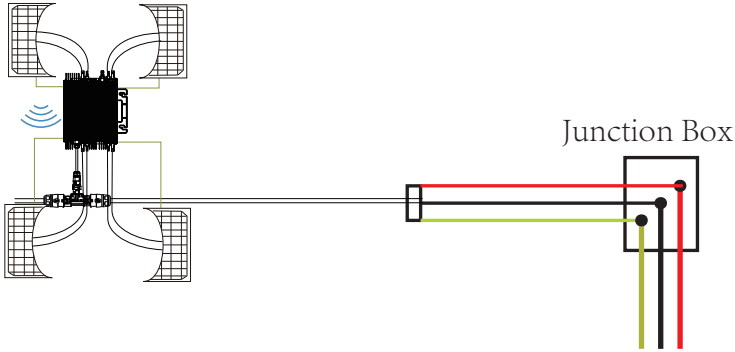

Step 5 - Connect Microinverter to the PV Modules

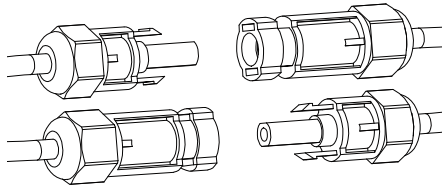

General Guidelines:

- PV modules should be connected to DC input ports of a Microinverter.
- In order to meet the relevant regulatory requirements, the cable length must be <math>< 3M</math>. Please consult the local power operator to make sure that the DC cable complies with local regulations.

NOTE: When plugging in the DC cables, if AC already available, the Microinverter should immediately blink red light and will start work within the setting time (default 60 seconds). If AC is not available, the red light will blink 3 times quickly and repeat after one second until AC is connected.

Microinverter System Operating Instructions

To operate the Microinverter PV system:

- Turn ON the AC circuit breaker on each Microinverter AC branch circuit.
- Turn ON the main utility-grid AC circuit breaker. Your system will start producing power after a one-minute waiting time.

-
-
3. The units should start blinking red one minutes after turning on the AC circuit breaker. Then blue led blinking. This means they are producing power normally, the faster blinking of the blue led means more power generated.
 4. Configure the internal wifi module according to its user manual.
 5. The Microinverters will start to send performance data over wifi module to the network every 5 minutes.It enables customers to monitor performance data of each Microinverter through website and APP.

When AC power is applied but the Microinverter not started up, about 0.1A current and 25VA power for each Microinverter may be measured by a power meter. This power is reactive power,not consume from utility grid.

Troubleshooting

Qualified personnel can use the following troubleshooting steps if the PV system does not operate correctly:

Status Indications and Error Reporting

Start up LED

One minute after DC power is first applied to the Microinverter,one short red blinks indicate a successful Microinverter startup sequence, be equal or greater than two short red blinks after DC power is first applied to the Microinverter indicate a failure during Microinverter setup.

Operation LED

Flashing Slow Blue	- Producing small power
Flashing Fast Blue	- Producing big power
Flashing Red	- Not producing power
Red blinking two times	- DC low-voltage or high-voltage
Red blinking seven times	- Grid failure

GFDI Error

A four time red LED indicates the Microinverter has detected a Ground Fault Detector Interrupter (GFDI) error in the PV system. Unless the GFDI error has been cleared, the LED will remain four times blinking.

Other Faults

All other faults can be reported to the website and APP.

WARNING: Never disconnect the DC wire connectors under load. Ensure that no current is flowing in the DC wires prior to disconnecting. An opaque covering may be used to cover the module prior to disconnecting the module.

Troubleshooting a non-operating Microinverter

There are two possible overall areas of trouble:

- A. The Microinverter itself may be having problems.
- B. The Microinverter itself is working fine but the communication between Microinverter and network has problem. The items below refer to Microinverter issues, not communication issues:

One quick way to tell whether the issue is the Microinverter or the communication problem:

Diagnosing from the network:

- a. No-Data-Display: The website and APP don't display any data. Check the network configuration.
- b. Only display Microinverter is online but no data. This maybe because server is updating.

To troubleshoot a non-operating Microinverter, Follow the steps below in order:

1. Verify the utility voltage and frequency are within ranges shown in the Technical Data section of this manual.
2. Check the connection to the utility grid. Disconnect AC firstly, then disconnect DC and make sure the utility grid voltage can be measured at AC connector. Never disconnect the DC wires while the Microinverter is producing power. Re-connect the DC module connectors and watch for three short LED flashes.
3. Check the AC branch circuit interconnection between all the Microinverters. Verify each inverter is energized by the utility grid as described in the previous step.
4. Make sure that any AC breaker are functioning properly and are closed.
5. Check the DC connections between the Microinverter and the PV module.
6. Verify the PV module DC voltage is within the allowable range shown in the Technical Data of this manual.
7. If the problem still persists, please contact technical support.

WARNING: Do not attempt to repair the Microinverter. If troubleshooting methods fail, please call for Technical Support

Replacement

Follow the procedure to replace a failed Microinverter

- A. Disconnect the Microinverter from the PV Module, in the order shown below:
1. Disconnect the AC by turning off the branch circuit breaker.
 2. Disconnect the AC connector of the Microinverter.
 3. Cover the module with an opaque cover.
 4. Disconnect the PV module DC wire connectors from the Microinverter.
 5. Remove the Microinverter from the PV array racking.
- B. Install a replaced Microinverter to the bracket then remove the opaque cover.
Remember to observe the flashing LED light as soon as the new Microinverter is plugged into the DC cables.
- C. Connect the AC cable of the replacement Microinverter.

Technical Data

WARNING: Be sure to verify the voltage and current specifications of your PV module match with those of the Microinverter. Please refer to the datasheet or user manual.

WARNING: You must match the DC operating voltage range of the PV module with the allowable input voltage range of the Microinverter.

WARNING: The maximum open circuit voltage of the PV module must not exceed the specified maximum input voltage of the inverter.

M130/160/180G4 Microinverter Datasheet

Model	SUN-M130G4- EU-Q0-I	SUN-M160G4- EU-Q0-I	SUN-M180G4- EU-Q0-I
PV String Input Data			
Max. PV Input Power(W)	210-460(4 Pieces)	210-560(4 Pieces)	210-630(4 Pieces)
Max. PV Input Voltage(V)	60		
Start-up Voltage(V)	20		
PV input voltage range(V)	20-60		
MPPT voltage range(V)	25-55		
Full Load MPPT Voltage Range(V)	29-55	31.5-55	33-55
Rated PV input voltage(V)	42.5		
Max. Input Short-Circuit Current (A)	27 × 4		
Max. Operating PV Input Current(A)	18 × 4		
No. of MPP Trackers/No. of Strings MPP Tracker	4/1		
Max. Inverter Backfeed Current To the Array	0		
AC Output Side			
Rated AC Output Active Power(W)	1300	1600	1800
Max.AC Output Apparent Power(VA)	1300	1600	1800
Rated AC output current (A)	5.7	7	7.9
Max.AC Output Current(A)	5.7	7	7.9
Max. Output Fault Current(A)	16		
Max. Output Overcurrent Protection (A)	42		
Rated output voltage/range (V)	230 0.85Un-1.1Un		
Grid Connection Form	L+N+PE		
Rated Output Grid Frequency/range(Hz)	50Hz/45Hz-55Hz		
Max. unit per branch	5	4	3
Power Factor Adjustment Range	0.9leading-0.9lagging/0.95leading-0.95lagging(VDE4105)		
Total Current Harmonic Distortion THDi	<3%		
DC Injection Current	<0.5%In		
Efficiency			
Max. Efficiency	96.5%		
Euro Efficiency	96.0%		
MPPT Efficiency	>99%		
Equipment Protection			
DC Polarity Reverse Connection Protection	yes		
AC Output Overcurrent Protection	yes		
AC Output Overvoltage Protection	yes		
AC Output Short Circuit Protection	yes		
Thermal Protection	yes		
DC Terminal Insulation Impedance Monitoring	yes		
Power Network Monitoring	yes		
Island protection monitoring	yes		
Earth Fault Detection	yes		
Overvoltage Load Drop Protection	yes		
Surge Protection Level	TYPE II(AC)		

M130/160/180G4 Microinverter Datasheet

Model	SUN-M130G4- EU-Q0-I	SUN-M160G4- EU-Q0-I	SUN-M180G4- EU-Q0-I
Interface			
Communication Interface	WiFi		
General Data			
Operating Temperature Range (°C)	-40 °C to +65 °C , >45 °C derating		
Permissible Ambient Humidity	0-100%		
Permissible Altitude (m)	2000m		
Noise (dB)	≤ 25 dB		
Ingress Protection(IP) Rating	IP 67		
Inverter Topology	Isolated		
Over Voltage Category	OVC II(DC),OVC III(AC)		
Cabinet Size (W*H*D) [mm]	358 × 255.5 × 36.5 (Excluding connectors and brackets)		
Weight [kg]	4.95		
Warranty [year]	Standard 10 years, extended warranty		
Type Of Cooling	Natural cooling		
Grid Regulation	IEC 61727, IEC 62116, CEI 0-21, EN 50549, NRS 097, RD 140, UNE 217002, OVE-Richtlinie R25, G98, VDE-AR-N 4105		
Safety EMC/Standard	IEC/EN 61000-6-1/2/3/4, IEC/EN 62109-1, IEC/EN 62109-2		

* Note : 15 years warranty (only installed in Germany and Austria)

M200/220G4 Microinverter Datasheet

Model	SUN-M200G4- EU-Q0-I	SUN-M220G4- EU-Q0-I
PV String Input Data		
Max. PV Input Power(W)	210-700(4 Pieces)	210-770(4 Pieces)
Max. PV Input Voltage(V)		60
Start-up Voltage(V)		20
PV input voltage range(V)		20-60
MPPT voltage range(V)		25-55
Full Load MPPT Voltage Range(V)	36.5-55	37.5-55
Rated PV input voltage(V)		42.5
Max. Input Short-Circuit Current (A)		27 × 4
Max. Operating PV Input Current(A)		18 × 4
No. of MPP Trackers/No. of Strings MPP Tracker		4/1
Max. Inverter Backfeed Current To the Array		0
AC Output Side		
Rated AC Output Active Power(W)	2000	2200
Max.AC Output Apparent Power(VA)	2000	2200
Rated AC output current (A)	8.7	9.6
Max.AC Output Current(A)	8.7	9.6
Max. Output Fault Current(A)		16
Max. Output Overcurrent Protection (A)		42
Rated output voltage/range (V)		230 0.85Un-1.1Un
Grid Connection Form		L+N+PE
Rated Output Grid Frequency/range(Hz)		50Hz/45Hz-55Hz
Max. unit per branch	3	3
Power Factor Adjustment Range	0.9leading-0.9lagging/0.95leading-0.95lagging(VDE4105)	
Total Current Harmonic Distortion THDi		<3%
DC Injection Current		<0.5%In
Efficiency		
Max. Efficiency		96.5%
Euro Efficiency		96.0%
MPPT Efficiency		>99%
Equipment Protection		
DC Polarity Reverse Connection Protection		yes
AC Output Overcurrent Protection		yes
AC Output Overvoltage Protection		yes
AC Output Short Circuit Protection		yes
Thermal Protection		yes
DC Terminal Insulation Impedance Monitoring		yes
Power Network Monitoring		yes
Island protection monitoring		yes
Earth Fault Detection		yes
Overvoltage Load Drop Protection		yes
Surge Protection Level	TYPE II(AC)	

M200/220G4 Microinverter Datasheet

Model	SUN-M200G4- EU-Q0-I	SUN-M220G4- EU-Q0-I
Interface		
Communication Interface	WiFi	
General Data		
Operating Temperature Range (°C)	-40 °C to +65 °C , >45 °C derating	
Permissible Ambient Humidity	0-100%	
Permissible Altitude (m)	2000m	
Noise (dB)	≤ 25 dB	
Ingress Protection(IP) Rating	IP 67	
Inverter Topology	Isolated	
Over Voltage Category	OVC II(DC),OVC III(AC)	
Cabinet Size (W*H*D) [mm]	358 × 255.5 × 36.5 (Excluding connectors and brackets)	
Weight [kg]	4.95	
Warranty [year]	Standard 10 years, extended warranty	
Type Of Cooling	Natural cooling	
Grid Regulation	IEC 61727, IEC 62116, CEI 0-21, EN 50549, NRS 097, RD 140, UNE 217002, OVE-Richtlinie R25, G98, VDE-AR-N 4105	
Safety EMC/Standard	IEC/EN 61000-6-1/2/3/4, IEC/EN 62109-1, IEC/EN 62109-2	

* Note : 15 years warranty (only installed in Germany and Austria)

Wiring Diagram

Sample Wiring Diagram Three Phase

M130/160/180/200/220G4 (4MPPT)

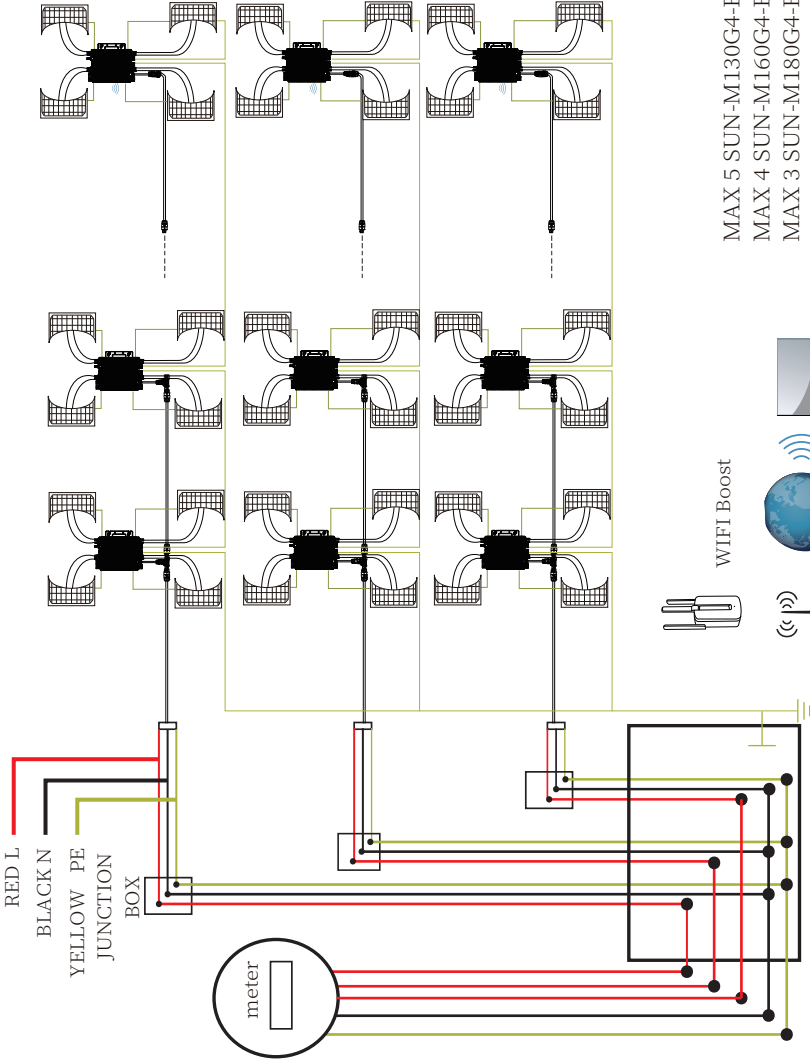

WiFi Boost



Monitoring system



Router

- MAX 5 SUN-M130G4-EU-Q0-I per Branch
- MAX 4 SUN-M160G4-EU-Q0-I per Branch
- MAX 3 SUN-M180G4-EU-Q0-I per Branch
- MAX 3 SUN-M200G4-EU-Q0-I per Branch
- MAX 3 SUN-M220G4-EU-Q0-I per Branch

M130/160/180/200/220G4 (4MPPT)

Sample Wiring Diagram Single Phase

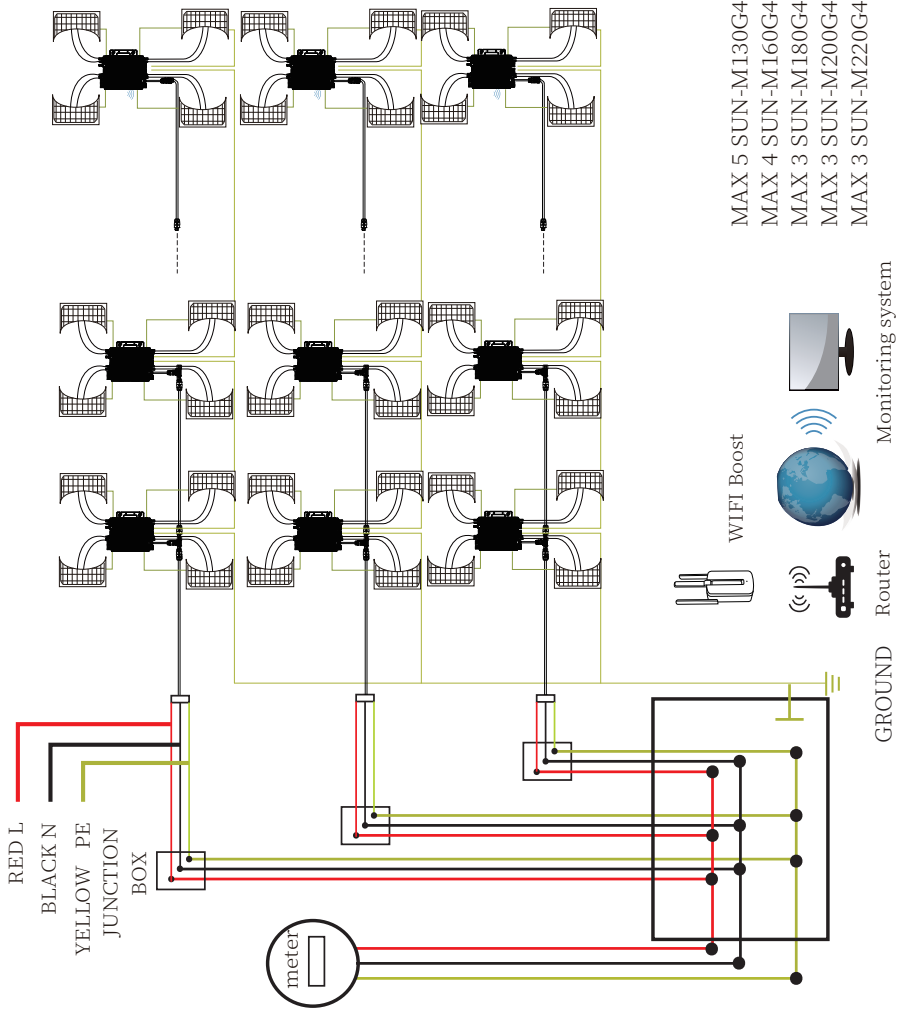

- MAX 5 SUN-M130G4-EU-Q0-I per Branch
- MAX 4 SUN-M160G4-EU-Q0-I per Branch
- MAX 3 SUN-M180G4-EU-Q0-I per Branch
- MAX 3 SUN-M200G4-EU-Q0-I per Branch
- MAX 3 SUN-M220G4-EU-Q0-I per Branch

Monitoring Platform

This series Microinverter has built-in WIFI modular which is able to connect router directly. For WIFI configuration, please check the manual of “Built-in WIFI modular Microinverter WIFI configuration Manual” .

Web monitoring address: <https://pro.solarmanpv.com>; (for Solarman distributor account)
<https://home.solarmanpv.com> (for Solarman end user account)

For mobile phone monitoring system, scan the QR code to download the APP.

Also you can find it by searching “solarman business” in App store or Google Play store, and this App is for distributor/installer.

Find it by searching “solarman smart” in App store or Google Play store and choose “solarman smart”, this app is for plant owner.



SOLARMAN Smart
for end user



SOLARMAN Business
for distributor/installer

How to connect the Microinverter to the router via web

1. Turn on the wireless network of your PC or smartphone.
2. The default password of the AP network is 12345678 if there's no nameplate that includes PWD:XXXXXXXX on the inverter body. If there's nameplate that includes PWD:XXXXXXXX on the inverter body then the AP network password is the "XXXXXX XXX": for example, the default password of AP network is "5c4db4d8" of the inverter SN:2302202012.

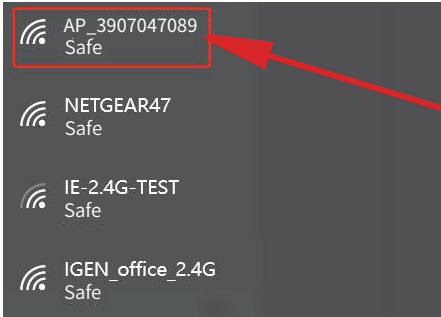

Microinverter SN: 2302202012 Built-in datalogger :3907047089

Also, the default password can be changed. If forgetting the modified password, please contact service@deye.com.cn for help.

3. Open a browser and enter **10.10.100.254**. Both username and password are "admin". (Recommended browser: IE 8+, Chrome 15+, Firefox 10 +).

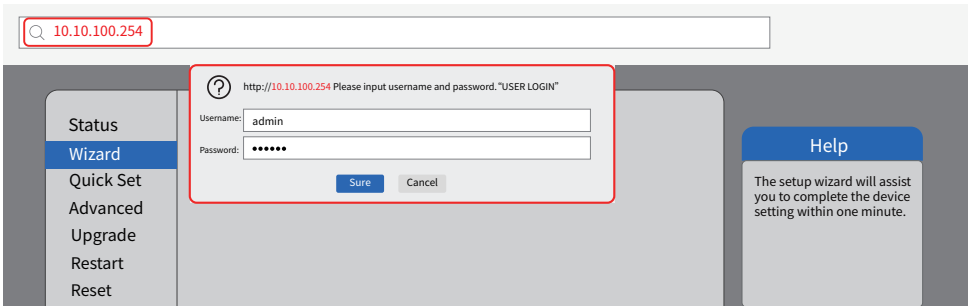

4. Browser jumps to "Status" page, the basic information is listed there.

Status

Wizard

Quick Set

Advanced

Upgrade

Restart

Reset

- Inverter information

Inverter serial number	---
Firmware version(main)	---
Firmware version(slave)	---
Inverter model	---
Rated power	--- W
Current power	--- W
Yield today	---kWh
Current power	---kWh

- Device information

Device serial number	3907047089
Firmware version	LSW3_14_FFFF_1.0.23
Wireless AP mode	Enable
SSID	AP_1704013242
IP address	10.10.100.254
MAC address	8C:D8:B3:71:8D:B0
Wireless STA mode	Disable
Router SSID	
Signal Quality	
IP address	
MAC address	

- Remote server information

Remote server A	Not connected
Remote server B	Not connected

Help

The device can be used as a wireless access point(AP mode) to facilitate users to configure the device, or it can also be used as a wireless information terminal (STA mode) to connect the remote server via wireless router.

Status of remote server

- Not connected: Connection to server failed last time. If under such status, please check the issues as follows: (1)check the device information to see whether IP address is obtained or not; (2)check if the router is connected to internet or not; (3)check if a firewall is set on the router or not;
- Connected: connection to server successful last time;
- Unknown: No connection to server.Please check again in 5 minutes.

5. Turn to "Wizard" page, click "Refresh" to search the wireless network. Select the target network and click "Next" .

Status

Wizard

Quick Set

Advanced

Upgrade

Restart

Reset

Please select your current wireless network:

<input checked="" type="radio"/>	IE-2.4G-TEST	54:A7:3:70:99:13	82	1
<input type="radio"/>	AP_1753738492	0:BE:D5:20:B8:2C	80	1
<input type="radio"/>	IGEN_office_2.4G	0:BE:D5:20:B8:2C	78	2
<input type="radio"/>	IGENTEST	E8:65:D4:F2:15:88	74	6
<input type="radio"/>	IGEN_office_2.4G	90:5D:7C:97:95:29	74	1
<input type="radio"/>	IGEN_office_2.4G	90:5D:7C:97:95:27	72	1
<input type="radio"/>	IGEN_office_2.4G	90:5D:7C:97:C9:E5	72	1
<input type="radio"/>	AP_1719065936	30:EA:E7:36:CF:B2	70	1
<input type="radio"/>	IGEN_office_2.4G	90:5D:7C:97:C9:E3	70	1
<input type="radio"/>	TESR+™ ?=, ;	4A:E:EC:9E:C3:3E	70	11
<input type="radio"/>	IGEN_office_2.4G	0:BE:D5:20:B7:EE	66	11

* Note: When RSSI of the selected WiFi network is lower than 15%, the connection may be unstable, please select other available network or shorten the distance between the device and router.

[Refresh](#)

Add wireless network manually:

Network name (SSID) (Note:case sensitive)

Encryption method

Encryption algorithm

[Next](#)

1
2
3
4

Help

The setup wizard will assist you to complete the device setting within one minute.

6. Enter the password and click Next.

Status

Wizard

Quick Set

Advanced

Upgrade

Restart

Reset

Please fill in the following information:

Password(8-64 bytes)
(Note: case sensitive)

Show Password

Obtain an IP address automatically

IP address

Subnet mask

Gateway address

DNS server address

1 2 3 4

Help

Most systems support the function of DHCP to obtain IP address automatically. Please select disable and add it manually if your router does not support such function.

7. Users can select any options below to enhance the security and click Next.

Status

Wizard

Quick Set

Advanced

Upgrade

Restart

Reset

Enhance Security

You can enhance your system security by choosing the following methods

Hide AP

Change the encryption mode for AP

Change the user name and password for Web server

1 2 3 4

Help

Change the encryption mode for AP
If you set password for the AP network, you will need to enter the passwording to connect to AP.

Change the user name and password for Web server
If you change the username and password for the web server, you will need to enter the new username and password to get access to the setting page.

8. If the setup is successful, the following page will pop up and click OK to reboot the Microinverter.

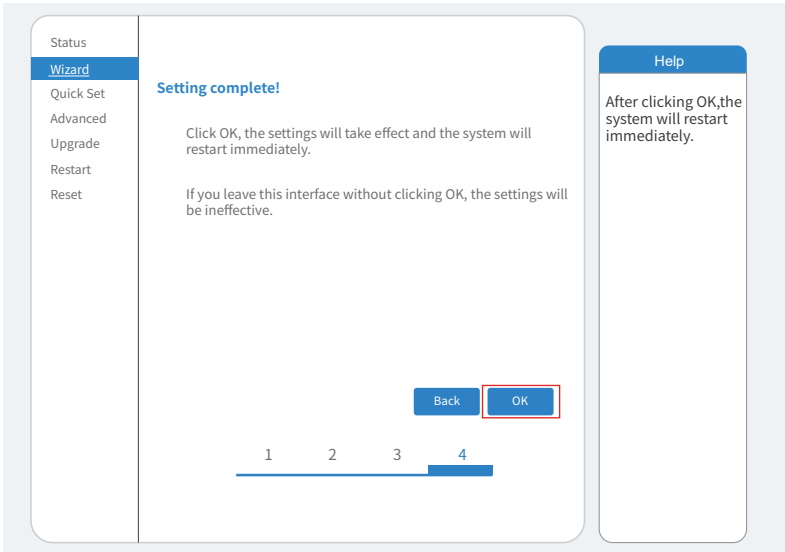

9. Connect to logger AP network again, then log in to 10.10.100.254 by Browser, and check the system info of "Status" page. After the network setting is done, the remote server A or B should be "connected".

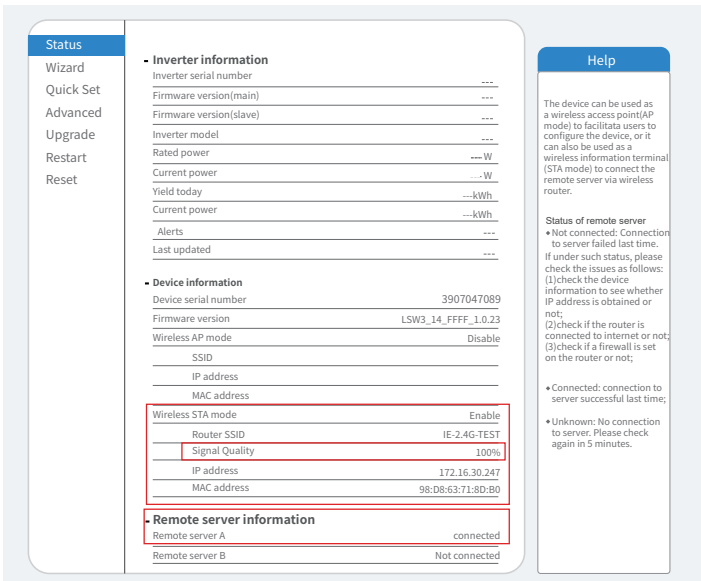

10. When it shows "connected" which means this Microinverter has connected solarman platform successfully. Generally speaking, it will be online after 10-15min after configuration successfully at the first time.

How to connect in APP

1. Registration

Open the app of SOLARMAN Smart and register an account.
Click "Register" and create your account here.

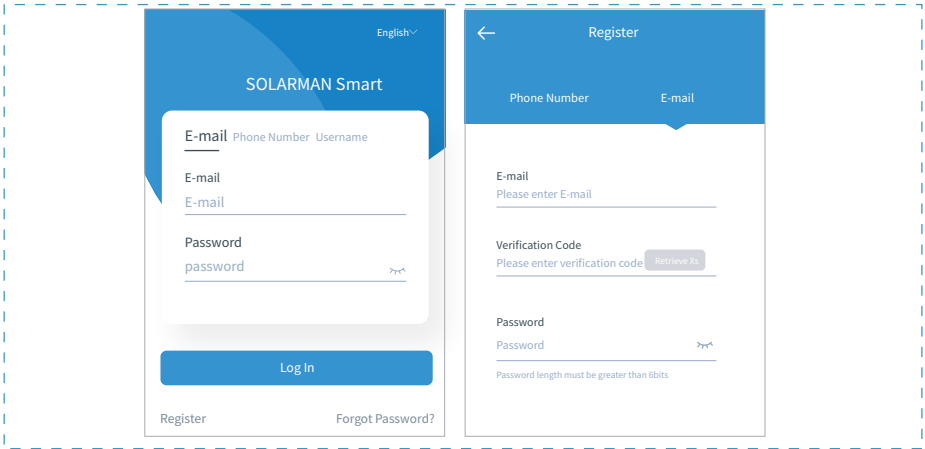

2. Create a Plant

Click "Add Now" to create your plant.
Please fill in plant basic info and other info here.

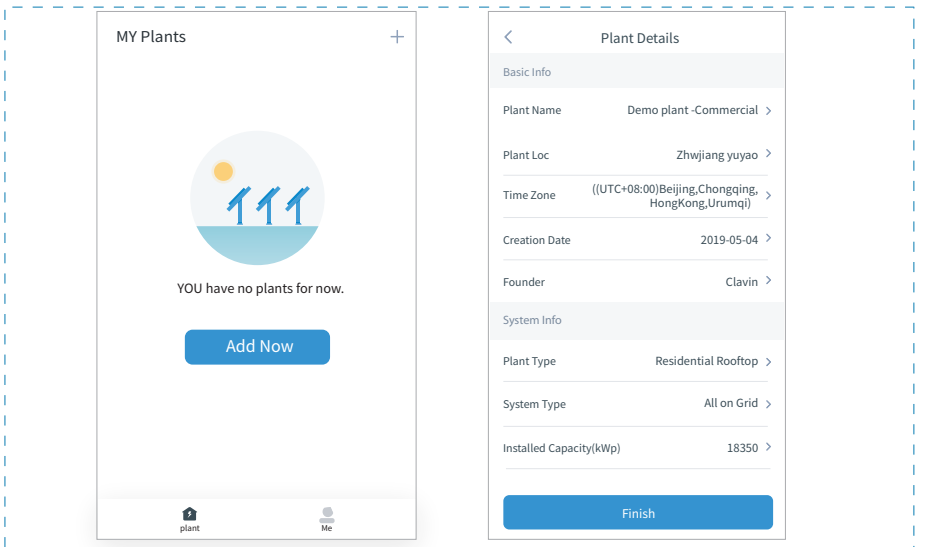

3. Add a Logger

Optional 1: Enter the logger SN manually.

Optional 2: Click the icon in the right and scan the QR code to enter logger SN.

You can find logger SN on the carton packaging or on the logger body.

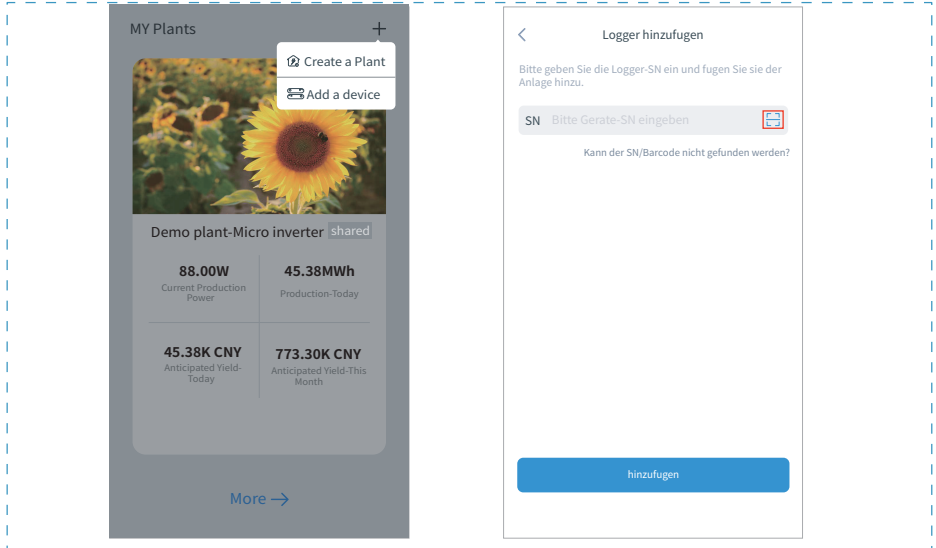

4. Network Configuration

After the logger is added, please configure the network to ensure normal operation.

Go to "Plant Details"->"Device List", find the target SN and click " Device Networking".

If showing "online" which means the datalogger of the inverter connects the solarman platform successfully. Then you will be able to check the plant info on the platform.

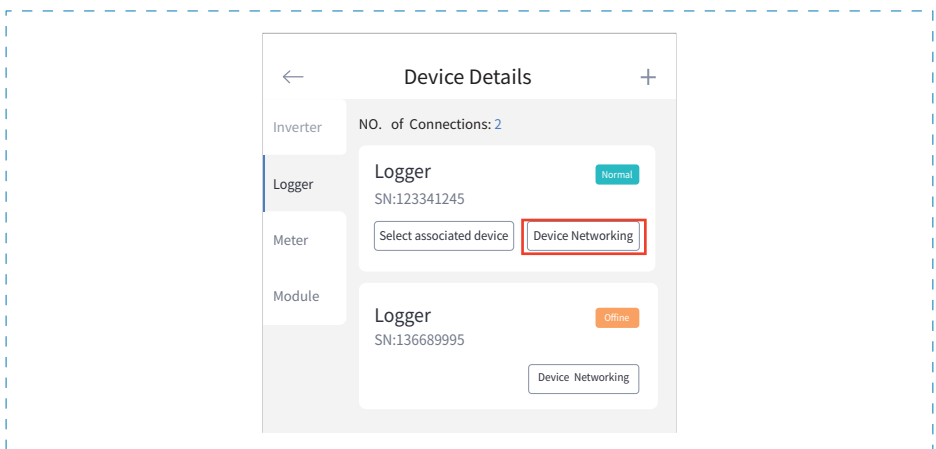

Maintenance

Deye microinverters do not require any specific regular maintenance.

Troubleshooting

If you have any question you can't handle during using Deye products, please contact with our after services by email: service@deye.com.cn, details can refer to products' warranty.

EU Declaration of Conformity



within the scope of the EU directives

- Radio Equipment Directive 2014/53/EU (RED)
- Restriction of the use of certain hazardous substances 2011/65/EU (RoHS)

NINGBO DEYE INVERTER TECHNOLOGY CO., LTD. confirms herewith that the products described in this document are in compliance with the fundamental requirements and other relevant provisions of the above mentioned directives. The entire EU Declaration of Conformity and certificate can be found at <https://www.deyeinverter.com/download/#microinverter-4>.

EU Declaration of Conformity

Product: **Utility-Interactive Inverter**

Models: SUN-M130G4-EU-Q0-I; SUN-M160G4-EU-Q0-I; SUN-M180G4-EU-Q0-I;
SUN-M200G4-EU-Q0-I;SUN-M220G4-EU-Q0-I;

Name and address of the manufacturer: Ningbo Deye Inverter Technology Co., Ltd.
No. 26 South YongJiang Road, Daqi, Beilun, NingBo, China

This declaration of conformity is issued under the sole responsibility of the manufacturer. Also this product is under manufacturer's warranty.

This declaration of conformity is not valid any longer; if the product is modified, supplemented or changed in any other way, as well as in case the product is used or installed improperly.

The object of the declaration described above is in conformity with the relevant Union harmonization legislation: The restriction of the use of certain hazardous substances (RoHS) Directive 2011/65/EU and the Radio Equipment Directive (RED) 2014/53/EU.

References to the relevant harmonized standards used or references to the other technical specifications in relation to which conformity is declared:

EN 62109-1:2010	●
EN 62109-2:2011	●
EN 300328 V 2.2.2:2019	●
EN 301489-1 V 2.2.3:2019	●
EN 301489-17 V 3.2.4:2020	●
EN 55011:2016+A1+A11+A2	●
EN 62920:2017+A11+A1	●
EN IEC 61000-6-1:2019	●
EN IEC 61000-6-2:2019	●
EN IEC 61000-6-3:2021	●
EN IEC 61000-6-4:2019	●
EN IEC 62311:2020	●
CISPR 11:2015+A1+A2	●

Nom et Titre / Name and Title:

Bard Dai
Senior Standard and Certification Engineer
宁波德业逆变器技术有限公司
NINGBO DEYE INVERTER TECHNOLOGY CO., LTD.

Au nom de / On behalf of:

Ningbo Deye Inverter Technology Co., Ltd.

Date / Date (yyyy-mm-dd):

2024-10-25

A / Place:

Ningbo, China

EU DoC – vZ

Ningbo Deye Inverter Technology Co., Ltd.
No. 26 South YongJiang Road, Daqi, Beilun, NingBo, China

NINGBO DEYE INVERTER TECHNOLOGY CO., LTD.

Add.: No.26 South YongJiang Road, Daqi, Beilun, NingBo, China.

Tel.: +86 (0) 574 8622 8957

Fax.: +86 (0) 574 8622 8852

E-mail: service@deye.com.cn

Web.: www.deyeinverter.com